

Niche Installation

Installation Guide For –

Gainsborough
91000 & 91350
(with pilasters)

Regency
91200 & 91300
(with casing)

Please
Read And
Follow All
Installation
Instructions
Carefully

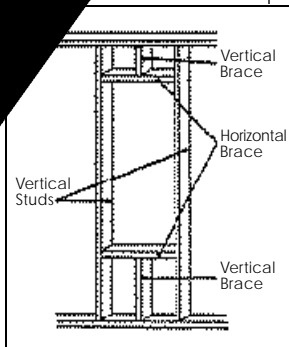

Figure 1

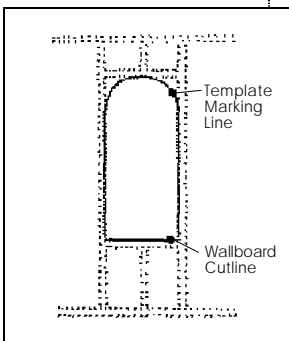

Figure 2

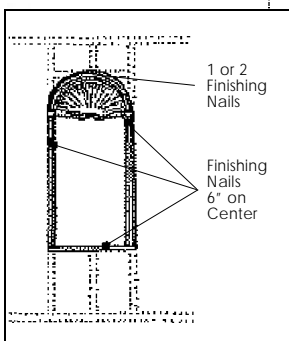

Figure 3

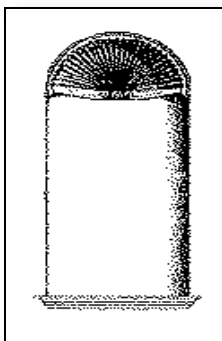

Figure 4

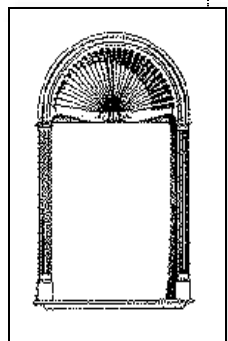

Figure 5

1. Framing

- The Gainsborough Niche requires framing out from or into a new or existing wall.
- Refer to rough opening dimensions and install: (figure 1)
 - vertical studs
 - horizontal braces
 - vertical braces

2. Wall Prep

- Install wallboard.
- Mark locations of studs and braces on wallboard.
- Mark wallboard along line just above bottom horizontal brace between studs. (figure 2)

3. Cutting Wallboard

- Using face of niche as a template, trace cutline on wall, position bottom to rest on horizontal brace. Then cut wallboard. (figure 2)

4. Niche Installation

- Place niche into rough opening, with bottom resting on horizontal brace.
- **Important** – Niche face should be flush with face of wallboard and check for level/plumb.
- Screw or nail into bracing and studs. (figure 3)

5. Shelf Installation

- Apply adhesive to back of shelf bracket; position shelf level to bottom of niche and center.
- Toenail or screw into horizontal brace. (figure 4)

6. Rim and Casing or Pilaster Installation

Rim and Casing Installation

- Don't cut plinths off rim.
- Center rim over niche; leaving scallops of niche exposed.
- Check level of rim; if not level, pull out or push in sides of rim.
- Screw or nail into place.
- Measure distance between rim and shelf bracket, cut casing to fit.
- Level/plumb casing and nail in place.

Rim and Pilaster Installation

- Cut plinths off rim.
- Center rim over niche; leaving scallops of niche exposed.
- Check level of rim; if not level, pull out or push in sides of rim.
- Screw or nail into place.
- Measure distance between rim and shelf bracket, trim pilaster from bottom if required.
- Level/plumb casing and nail in place. (figure 5)

Instructions continued on back

7. Finishing

- Countersink all nails and screws then spackle.
- Caulk between elements and wall.
- Spackle and/or Bondo between shelf bracket and niche.
- Sand and reprime if needed.
- Paint with high quality latex or oil-based paint.
- **Do Not** use lacquer-based paints.

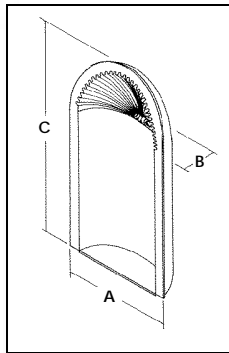

Overall

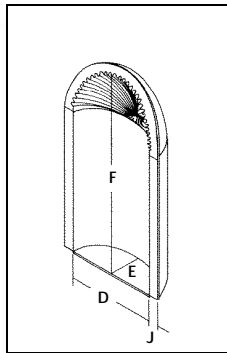

Inside

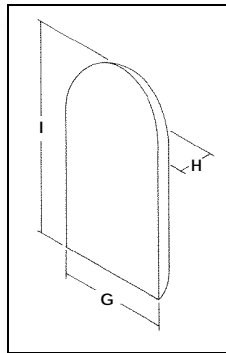

Rough Opening

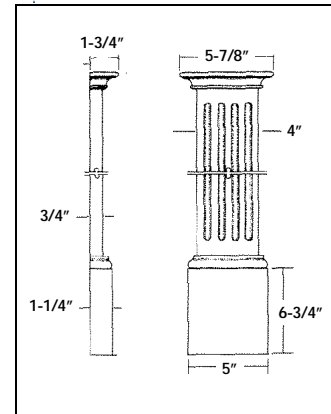

Pilaster

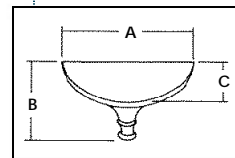

Shelf Bracket

| Niche Unit Sets | | 91000 | 91350 | |
|-----------------|------------------|----------|---------|---------|
| Niche Unit | Overall | Width A | 27-1/4" | 32-7/8" |
| | | Depth B | 9" | 9-7/8" |
| | | Height C | 56" | 58-1/2" |
| | Inside | Width D | 25-1/2" | 31" |
| | | Depth E | 7-3/4" | 9" |
| | | Height F | 53-5/8" | 56-1/2" |
| Rough Opening | Width G | 28" | 33-1/2" | |
| | Depth H | 9-1/4" | 10-1/2" | |
| | Height I | 56-1/2" | 59-1/2" | |
| Pilaster | See Illustration | Width J | 5-7/8" | 5-7/8" |
| | | Proj K | 1-3/4" | 1-3/4" |
| Niche Rim | Overall | Width | 32-5/8" | 37" |
| | | Height | 17-1/2" | 19-1/8" |
| | Inside | Width | 25-3/4" | 30" |
| | | Height | 14" | 15-5/8" |
| Shelf Bracket | Overall | Width A | 34-3/4" | 41" |
| | | Height B | 3-1/8" | 3-1/4" |
| | | Proj C | 3-1/8" | 3-1/8" |

Pour instructions de pose, consultez votre distributeur
 Voor verwerkingstips, zie uw groothandelaar
 Für Gebrauchsanweisung, siehe Ihre Grosshandler
 Consulta con su distribuidor por direcciones de instalación

Note: Call your local dealer with any questions.

FOCAL POINT
 ARCHITECTURAL PRODUCTS®
"The Difference Is In The Details"

3006 Anaconda Drive
 Tarboro • North Carolina • 27886
 p 800.662.5550 f 800.352.9049
 www.focalpointap.com